



Powerful Synergies



COPMA[®]

300

TOP RANGE
MODEL

COPMA 300

Performance & Power

300 HAS COMPACT DIMENSIONS AND OPTIMIZED WEIGHTS WITH A CUSTOMIZED DESIGN FOR MORE POWER AND RELIABILITY AT EVERY OPERATOR NEED.

- **TOP RANGE - HEAVY RANGE model, load category - 30 Ton/Mt**
- **High tensile strength steel**
- **Efficient safety system**
- **Reliability, speed and precision**
- **Extra long working life cycle**
- **Easier maintenance operations**





THE MOST POWERFUL CRANE FOR THE TOUGHEST MARKETS



COPMA 300

More Safety & Security

**DESIGNED WITH THE HIGHEST
HYDRAULIC SYSTEMS AND THE
TOUGHEST STRUCTURAL STEEL
TO PERFORM THE MAXIMUM
LIFTING CAPACITY.**

- **Superior Hydraulic Technology**
- **Dynamic Electronic Controls**
- **High Degree of User Friendliness**
- **Efficiency and Reliability thanks to superior structural features**
- **More Efficiency with advanced electronic controls**





DESIGNED
FOR FLEXIBLE
SERVICES



COPMA 300

Technical Features

**CUTTING EDGE FEATURES FOR
MAXIMUM LIFTING POWER,
STABILITY AND OPERATIONAL
SAFETY IN EVERY WORKING
CONDITION.**

Standard features

- easy use



- control



- structure



optional features

- easy use



- control



*CE version

‡Only for CE version/600° for NO CE version
OPT. for NO CE version





High Speed Extension

Hydraulic system for reducing load losses and bottlenecks for the correct output sequence of the extensions by increasing the speed of 30%-60% thanks to the regenerative valve. Greater continuous performance thanks to lower fluid temperature.



Electronic Radio Display

A display on the remote control allows the operator to maintain the total control of all the crane functions in real time by managing the work mode, the stability control, and oversee any maintenance and diagnostic messages.



Transport Alert Device

Sensors on the basement guarantee the correct closing of the beams and a column switch sensor indicates if the crane is in a folded position, no more than 4 Mt in height. The operator is warned with light and sound signals in the truck cabin.



Hydraulic Lifting Stabilizers 2.0

The stabilizer cylinder is lifted thanks to an auxiliary jack, allowing the vertical movement inside a bush or a rotation around a pin. This easy use system saves time and allows an efficient stabilizer set up.



Negative Boom System

The linkage on the articulation of the secondary boom permits the introduction of loads within restricted spaces. It enables the recovery of the deflection of the extension boom group due to the weight and the load raised on the extensions.

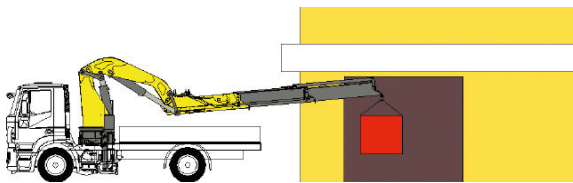

Radio Remote Control 3.0

Radio control with directly flanged actuation electronics with proportional distribution. The remote control allows operating the crane while constantly monitoring the areas of operation.



Crane Monitoring System 2.0

Crane stability control system TES2-TES3 with safety and overload controls and HPVE lifting speed management. Active control on 4-8 working areas according to the model and vehicle stability requirements.



Truck Electronic Stability 3.0

Active stability control for performance optimization according to the type of stabilization to guarantee maximum safety in all working conditions. Mandatory in the CE market, it helps a better vehicle-crane configuration.

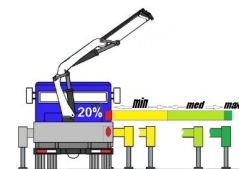

NCS
control
Negative Control System

Slope sensors mounted on the articulated booms of the crane, combined with the electronic control, manage the maximum vertical angle of the arms and the JIB preventing incorrect or dangerous movements by the operator.

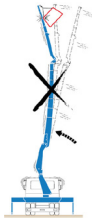

CCLS
structure
Constant Control Link

The cranes equipped with connecting rods on the articulations, with a constant lifting moment over the entire working arc, allow to 100% optimize the crane's capacity in positions close to the maximum vertical.

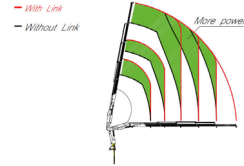

PJM
control
Power Jib Monitoring

The PJM system guarantees to operate with the maximum performance in every working condition thanks to a dynamic variation of the maximum pressure according to the crane arm angles.

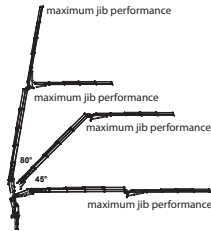

RES 2.0
structure
Rotation Endless System 2.0

Rotating system with bearing and double gearbox, equipped with clearance adjusting system with eccentric shaft. It provides the perfect transmission of the rotation with the bearing.

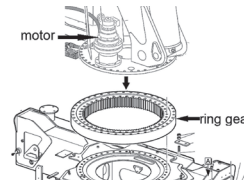

CMS 3.0
control
Crane Monitoring System 3.0

Crane stability control system TES2-TES3, with safety and overload controls medium high-range crane and HPVE lifting speed management. Active control on 4-8 working areas according to the model and vehicle stability requirements.

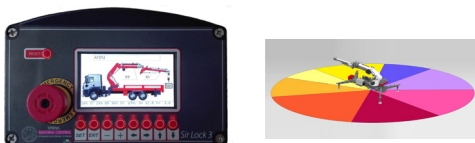

WLC
control
Winch Linear Control

The winch linear electronic control allows pulling the rope according to the working angle of the crane and the JIB. It optimizes the load control and makes every movement easier and safer.

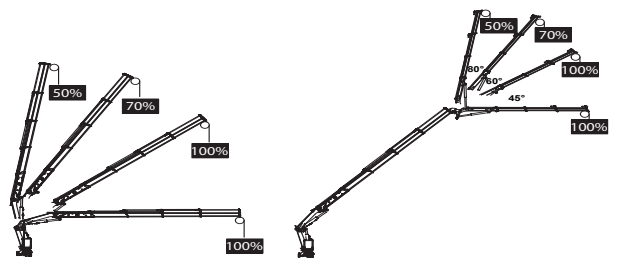

HPVh
easy use
High Power Velocity Hydraulic

Fully automatic hydraulic system for adjusting the crane lifting speed according to the maximum working pressure. With this system, the load capacity of the machine is optimized by reducing the dynamic structural effects.

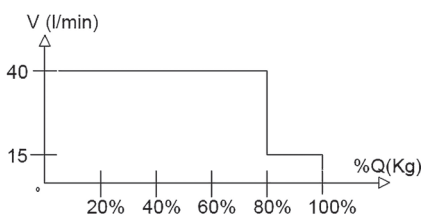

CRC 4.0
control
COPMA® Remote Connectivity 4.0

COPMA® Remote Connectivity 4.0 to the crane. Two-way communication by GPRS for real-time diagnosis and remote real-time parameter setting and/or adjustment.



300 TOP RANGE

Load Charts

3 extensions

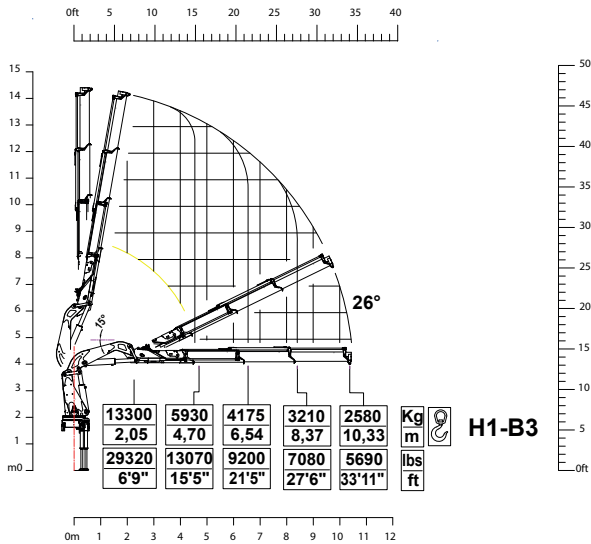

4 extensions

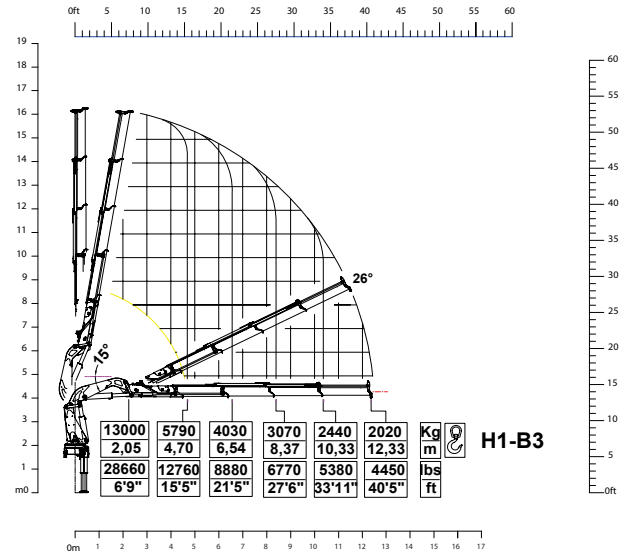

5 extensions

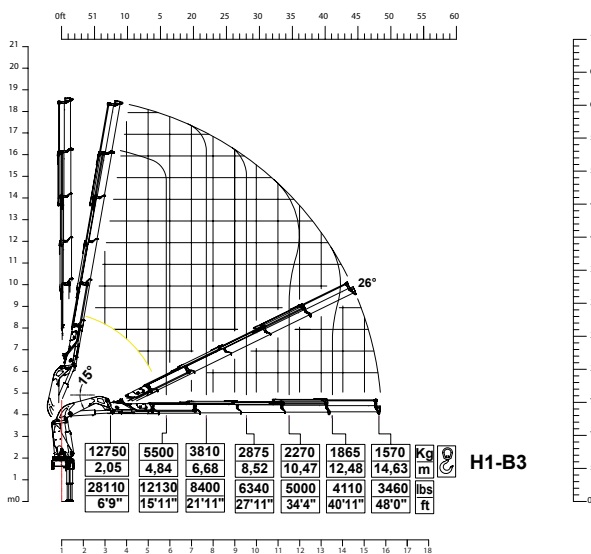

6 extensions

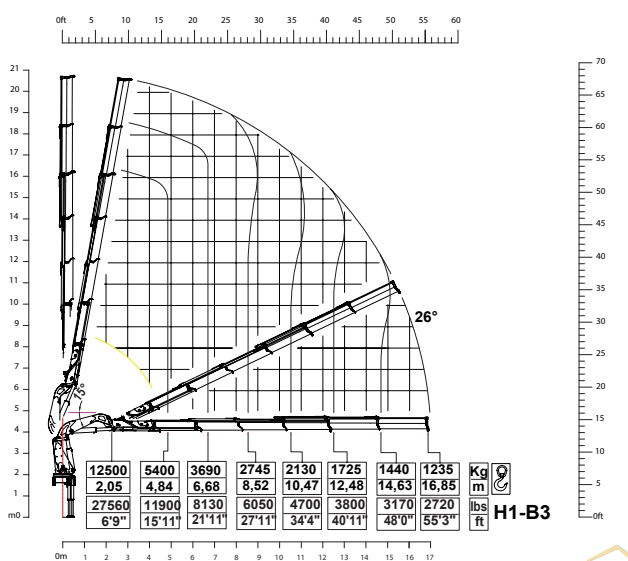

7 extensions

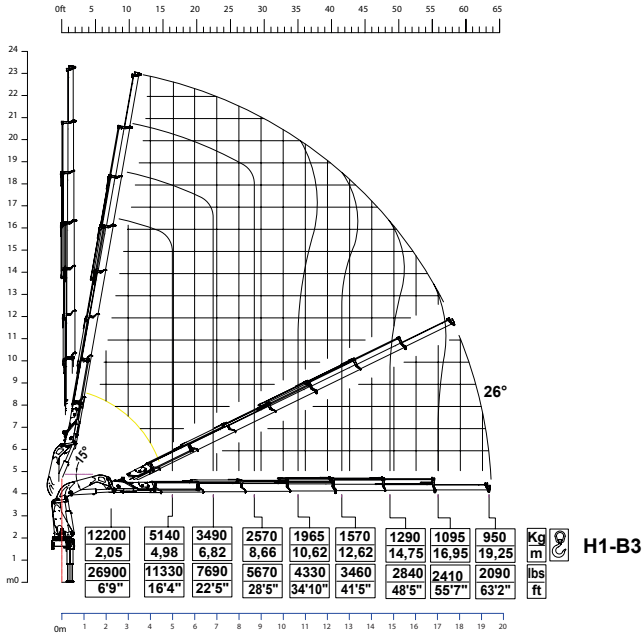

8 extensions

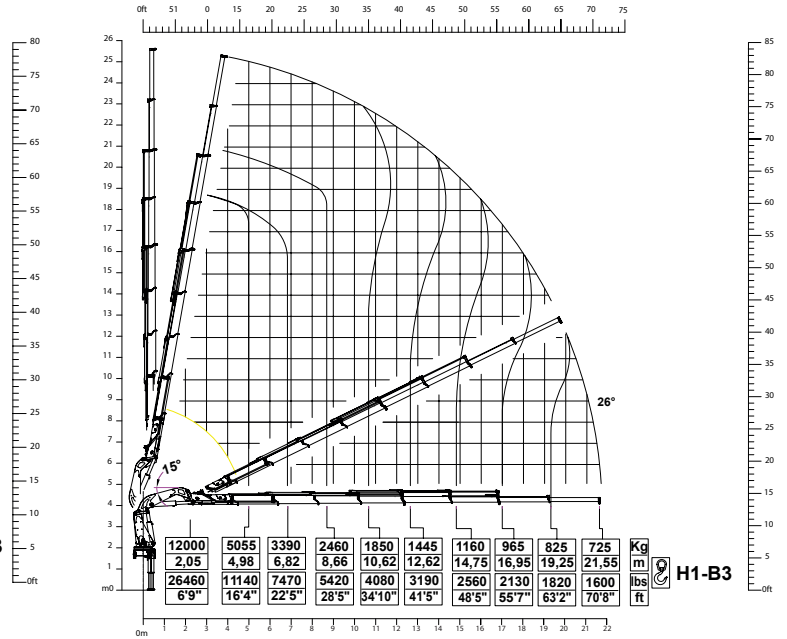

300.4 + J3

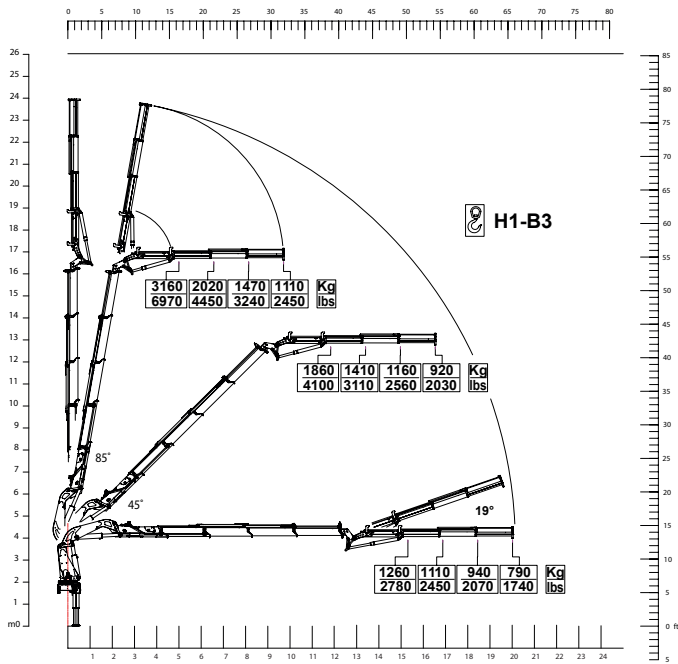

300.4 + J4

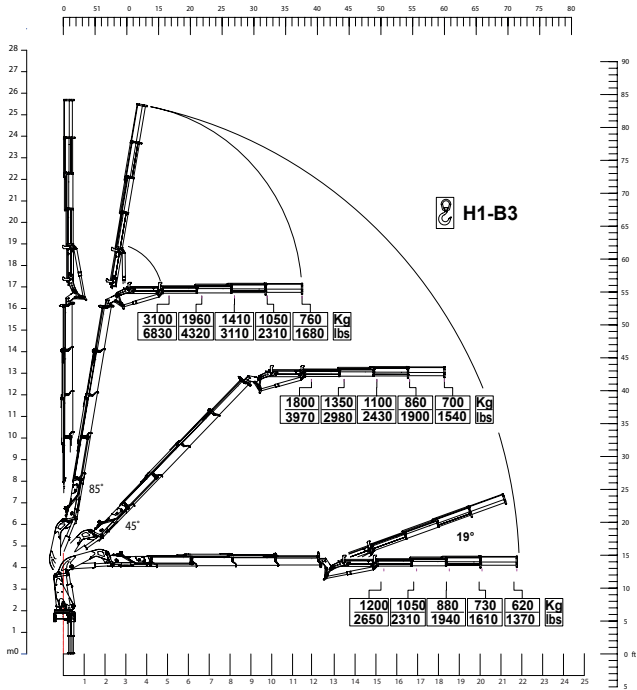

300.5 + J3

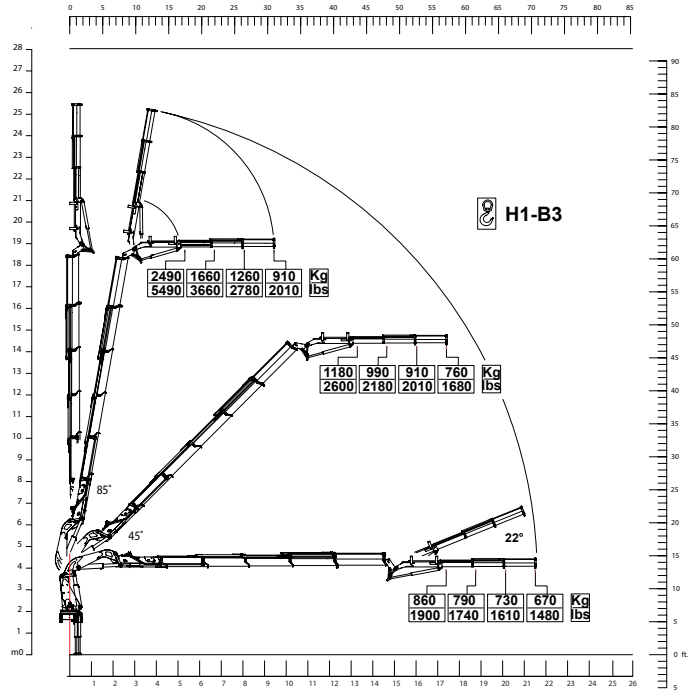

300.5 + J4

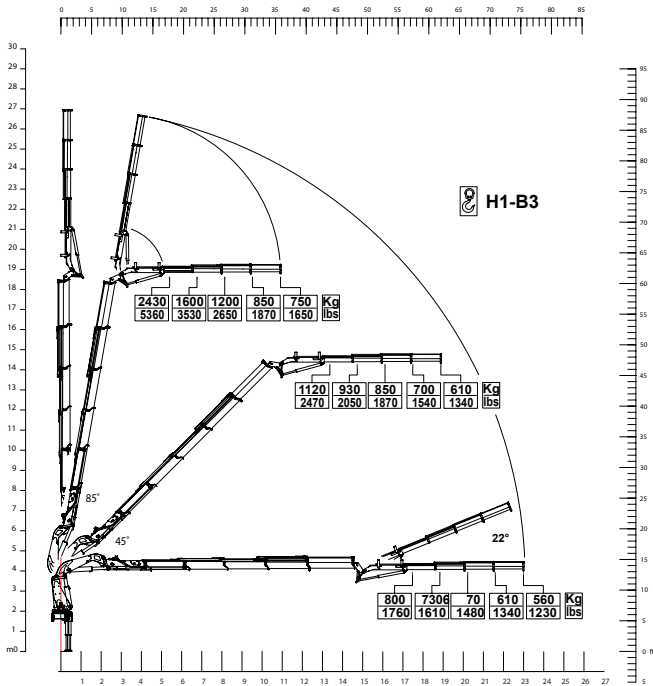

300.6 + J2

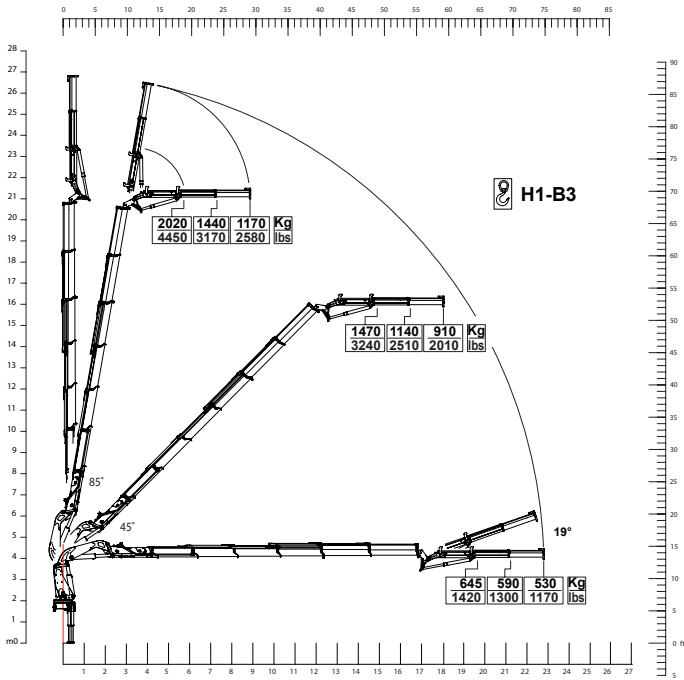

300.6 + J3

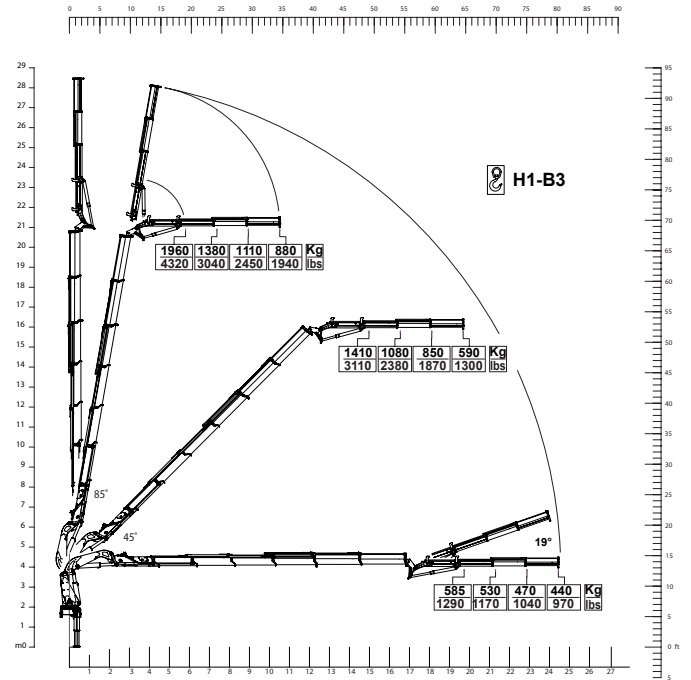

300.6 + J4

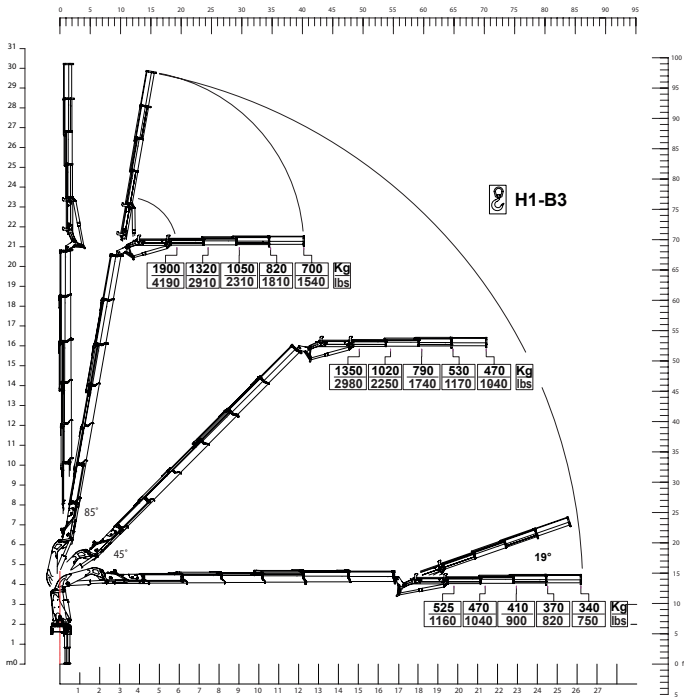

300 TOP RANGE

Crane Dimensions

back cabin left

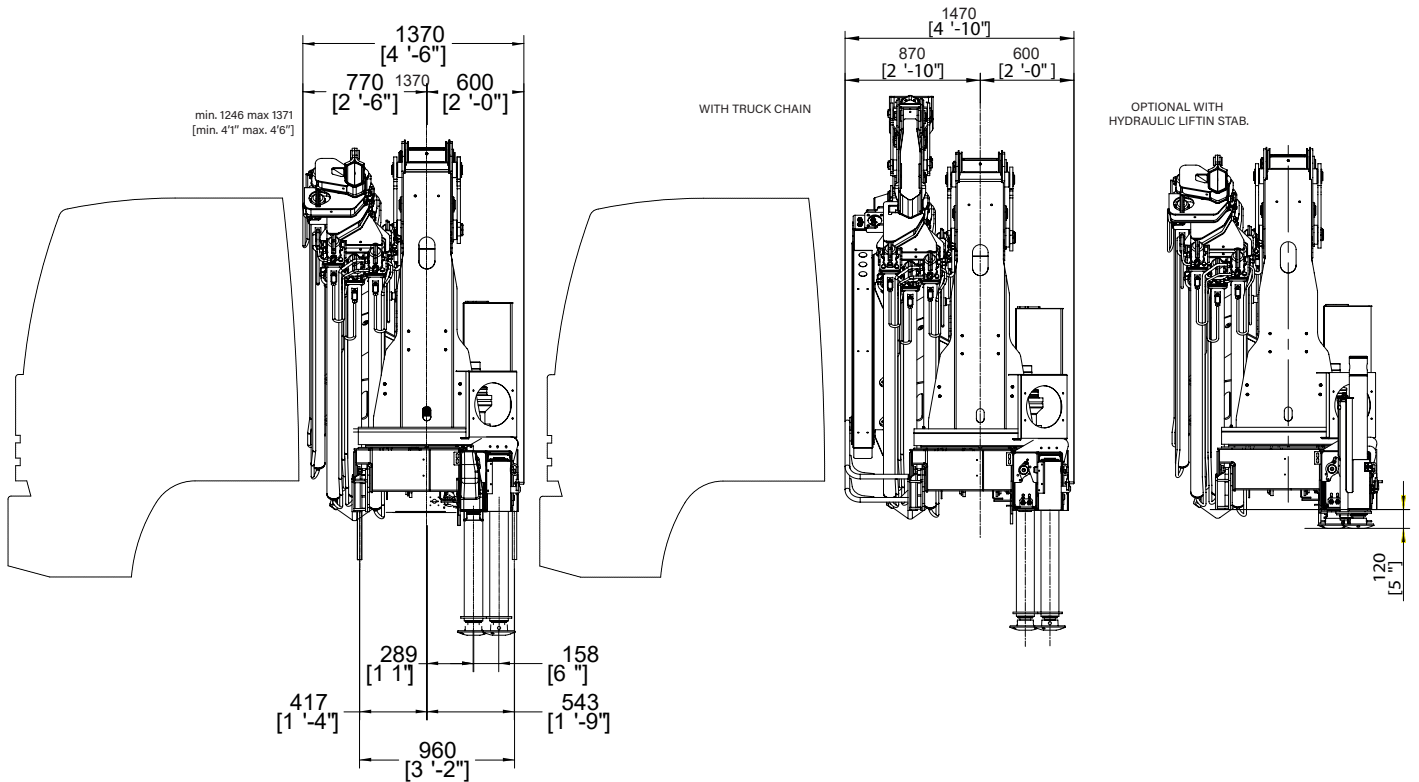

rear truck

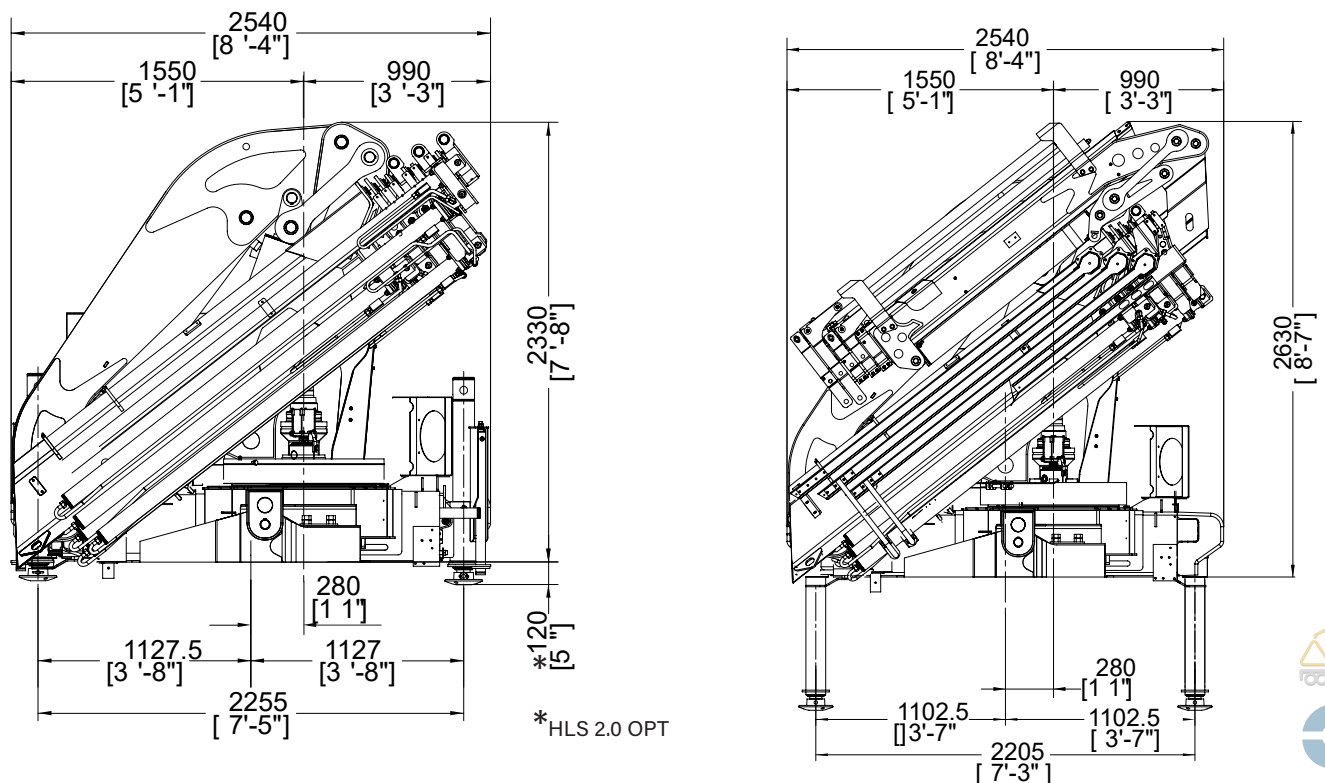

operational

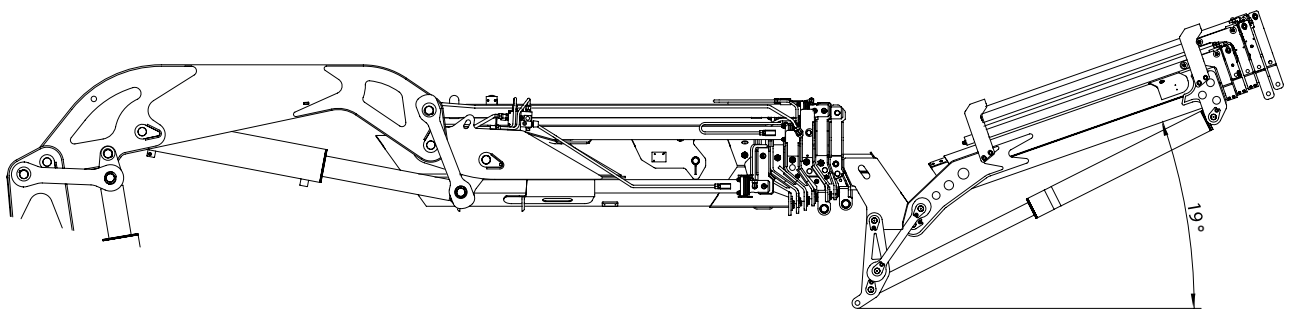
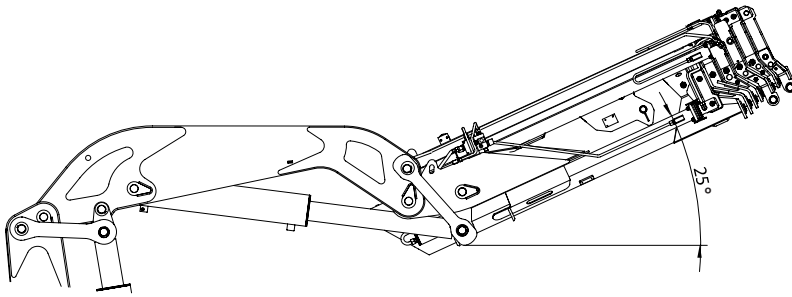

extended outriggers

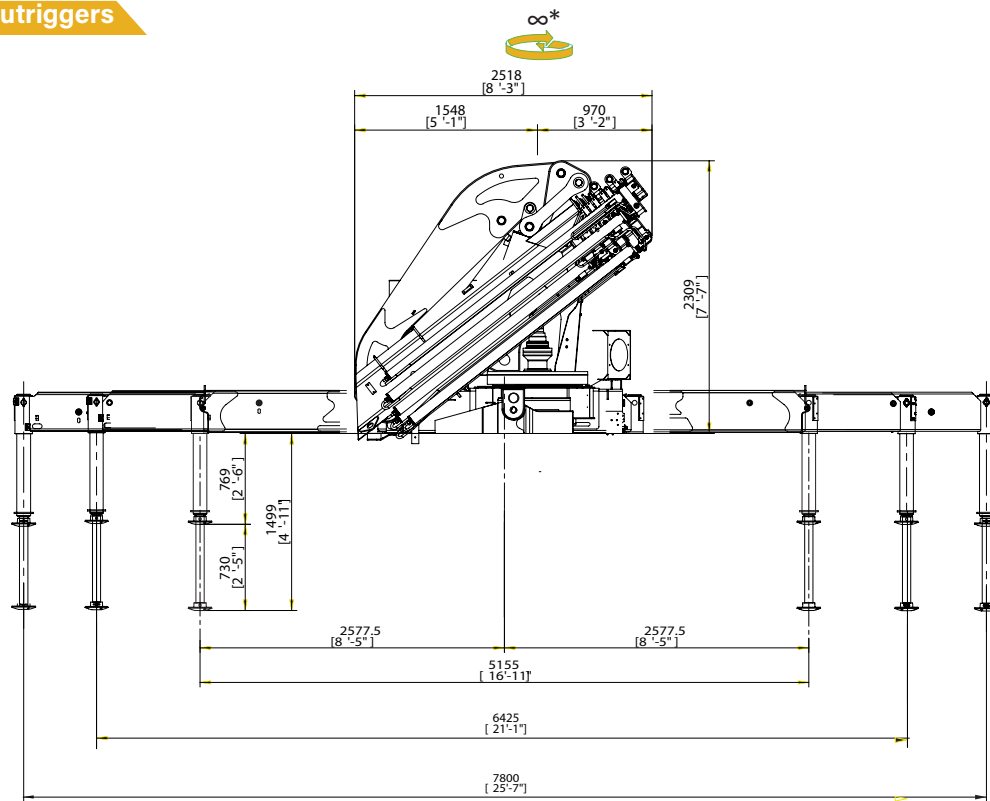

*600° for NO CE version









Note: technical features are not binding, the company reserves itself the right to any modification without notice











300 TOP RANGE

Technical Data

summarized data

									
	kN.m	bar	l/min	kg	°	mm	mm	mm	mm
300.3	273	310	50	3620	∞*	2448	1246	2309	5155/6425/7800
300.4	267	310	50	3800	∞*	2470	1267	2309	5155/6425/7800
300.4J3	267	310	50	4360	∞*	2470	1469	2595	5155/6425/7800
300.4J4	267	310	50	4420	∞*	2470	1469	2595	5155/6425/7800
300.5	261	310	50	3950	∞*	2475	1267	2309	5155/6425/7800
300.5J3	261	310	50	4510	∞*	2475	1447	2665	5155/6425/7800
300.5J4	261	310	50	4570	∞*	2475	1447	2665	5155/6425/7800
300.6	256,4	310	50	4100	∞*	2518	1342	2309	5155/6425/7800
300.6J2	256,4	310	50	4600	∞*	2518	1472	2665	5155/6425/7800
300.6J3	256,4	310	50	4660	∞*	2518	1472	2665	5155/6425/7800
300.6J4	256,4	310	50	4720	∞*	2518	1472	2665	5155/6425/7800
300.7	251	310	50	4225	∞*	2518	1340	2309	5155/6425/7800
300.8	246,92	310	50	4350	∞*	2518	1370	2309	5155/6425/7800

*600° for Extra E.C. market

									
	lbs.ft	psi	gal/min	lbs	°	ft/inc	ft/inc	ft/inc	ft/inc
300.3	18884	4495	13,1	7980	∞*	8'4"	4'1"	9'1"	16'11"/21'11"/25'7"
300.4	193000	4495	13,1	8377	∞*	8'4"	4'2"	9'1"	16'11"/21'11"/25'7"
300.4J3	193000	4495	13,1	9610	∞*	8'4"	4'10"	8'6"	16'9"/21'0"/25'7"
300.4J4	193000	4495	13,1	9750	∞*	8'4"	4'10"	8'6"	16'9"/21'0"/25'7"
300.5	192380	4495	13,1	8710	∞*	8'4"	4'2"	7'7"	16'11"/21'11"/25'7"
300.5J3	192380	4495	13,1	9940	∞*	8'4"	4'9"	8'9"	16'9"/21'0"/25'7"
300.5J4	192380	4495	13,1	10080	∞*	8'4"	4'9"	8'9"	16'9"/21'0"/25'7"
300.6	185000	4495	13,1	9040	∞*	8'4"	4'5"	7'7"	16'11"/21'11"/25'7"
300.6J2	185000	4495	13,1	10140	∞*	8'4"	4'10"	8'9"	16'9"/21'0"/25'7"
300.6J3	185000	4495	13,1	10270	∞*	8'4"	4'10"	8'9"	16'9"/21'0"/25'7"
300.6J4	185000	4495	13,1	10410	∞*	8'4"	4'10"	8'9"	16'9"/21'0"/25'7"
300.7	181626	4495	13,1	9295	∞*	8'4"	4'5"	7'7"	16'11"/21'11"/25'7"
300.8	179000	4495	13,1	9600	∞*	8'4"	4'6"	7'7"	16'11"/21'11"/25'7"

*600° for Extra E.C. market

technical data

Max. lifting moment	273 kNm	18884 ft.lbs
Max. hydraulic outreach	21.55 m	61'4"
Slewing angle	∞	∞
Slewing torque	3600 daNm	23652 ft.lbs
Stabilizer spread	5.14/6.4/7,8 mt	16'11"/21'11"/25'7"
Fitting space required (min./max)	1,24 m/1.47 m	4'6"/4'10"
Width folded	2,52 m	8'3"
Max. operating pressure	310 bar	4495 psi
Recommended pump capacity	50 l/min	13,1 US gal./min
Dead weight (vers. 3)	3620 kg	7980 lbs

Note: technical features are not binding, the company reserves itself the right to any modification without notice



COPMA 300



knuckle
boom
cranes



Powerful Synergies



CPS



**CPS
STEEL**

CPS GROUP S.P.A.

281 Via Emilia, Castel Bolognese (RA), 48014
Italy

T +39 0546 653 711

sales.cpsgroup@cps-group.com

service.cpsgroup@cps-group.com

cps-group.com



UNICERT
ISO 9001:2008



COPMA MODEL 300 TOP RANGE 3-2021 all rights reserved CPS GROUP