



Powerful Synergies



cps-group.com



COPMA[®]
42

ESSENTIAL
MODEL

COPMA 42

Performance & Power

**42 IS INNOVATIVE ENGINEERING
FOR TOP PRECISION, EFFICIENCY,
SPEED AND PERFORMANCE.
AN ESSENTIAL MASTERPIECE
OF LIFTING TECHNOLOGY.**

- **ESSENTIAL model, load category - 4 Ton/Mt.**
- **Essential in design, powerful in performance**
- **Robust arm system**
- **Simple and reliable**
- **Excellent operational safety**





**THE MOST
POWERFUL
CRANE FOR
THE TOUGHEST
MARKETS**



COPMA 42

More Safety & Security

**DESIGNED WITH THE HIGHEST
HYDRAULIC SYSTEMS AND THE
TOUGHEST STRUCTURAL STEEL
TO PERFORM THE MAXIMUM
LIFTING CAPACITY.**

- **Optimized and reliable hydraulic technology**
- **Column with high mechanical characteristics**
- **High Degree of User Friendliness**
- **Efficiency and Reliability thanks to essential design**
- **Excellent weight/performance ratio**





**DESIGNED
FOR FLEXIBLE
SERVICES**



COPMA 42

Technical Features

**CUTTING EDGE FEATURES
FOR MAXIMUM LIFTING
POWER, STABILITY AND
OPERATIONAL SAFETY IN EVERY
WORKING CONDITION.**

Standard features

- easy use



- control



- structure



optional features

- control





Manual Lifting Stabilizers 1.0

Manual lifting of the crane legs. The manual lifting of the legs helps the operator adjust its extension manually without additional assistance from electronics or hydraulic controls.

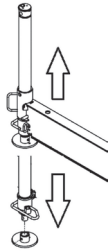

Transport Alert Device

Sensors on the basement control the correct closing of the beams and a column switch sensor indicates if the crane is in a folded position, no more than 4 Mt in height. The operator is warned with light and sound signals in the truck cabin.



Rotation Rack Pinion

The rotation system with rack and pinion is the best optimal solution for the most performative lifting capacity, it reduce the weights and crane dimension for the most compact configuration.



Constant Control Link

The cranes equipped with connecting rods on the articulations, with a constant lifting moment over the entire working arc, allow to 100% optimize the crane's capacity in positions close to the maximum vertical.

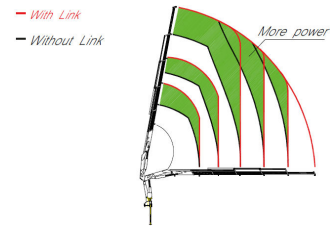

Radio Remote Control 3.0

Radio control with directly flanged actuation electronics with proportional distribution. The remote control allows operating the crane while constantly monitoring the areas of operation.



Radio Remote Control 2.0

Radio remote control with the electro-hydraulic actuator connected directly to the standard control valve. The remote control allows operating the crane while continually monitoring the areas of operation.

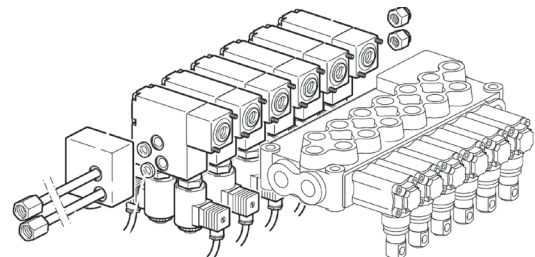

COPMA® Remote Connectivity 4.0

COPMA® Remote Connectivity 4.0 to the crane. Two-way communication by GPRS for real-time diagnosis and remote real-time parameter setting and/or adjustment.



42 ESSENTIAL

Load Charts

1 extensions

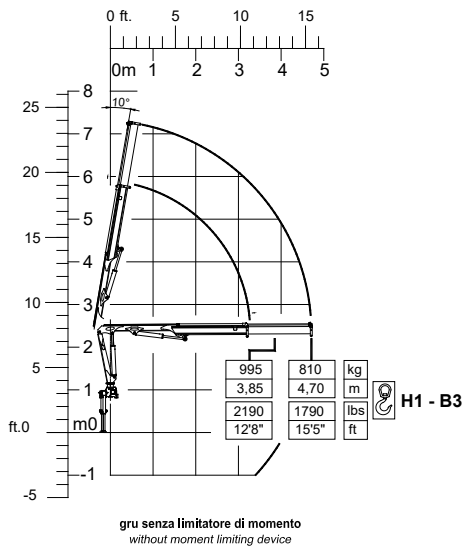

2 extensions

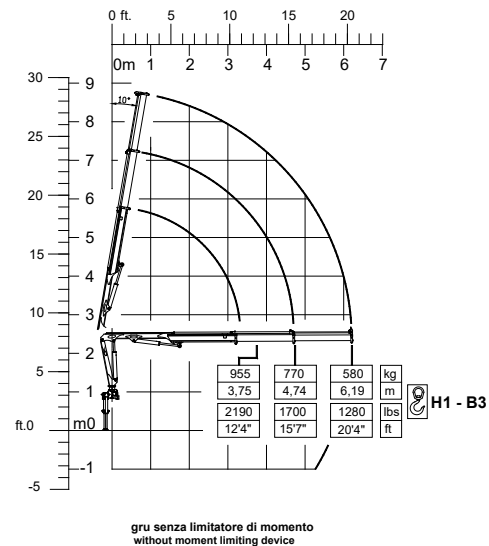

3 extensions

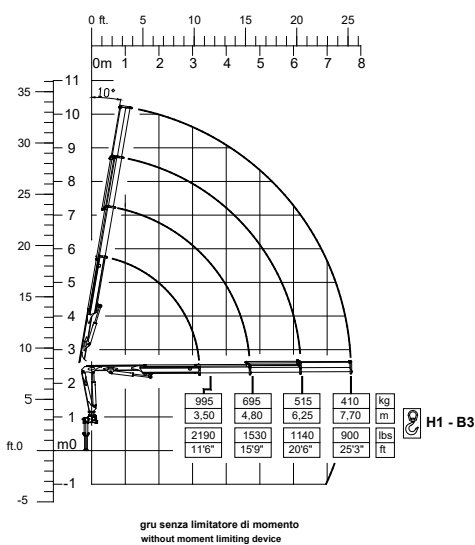

4 extensions

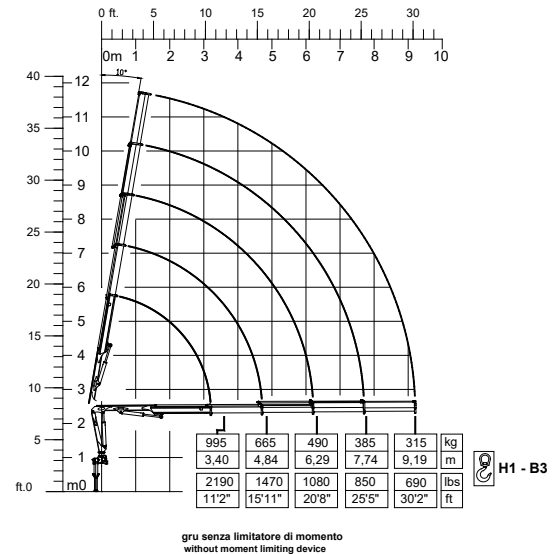

42 ESSENTIAL

Crane Dimensions

back cabin left

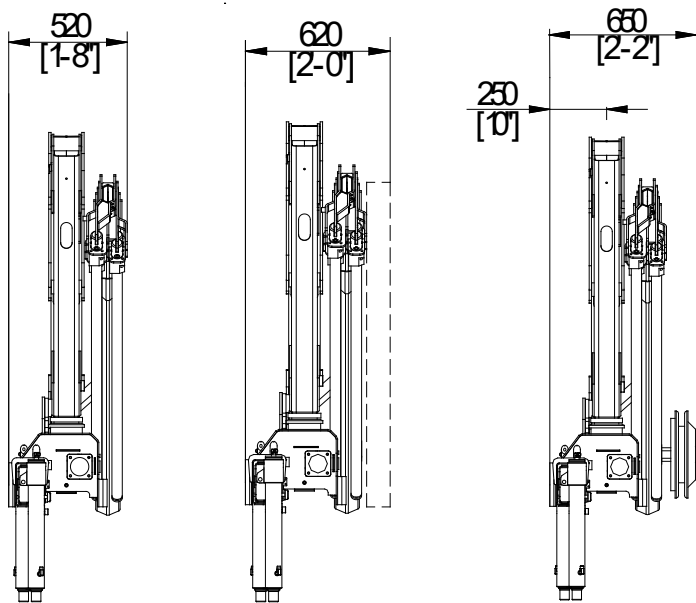

with TRACK CAN

with WHEEL



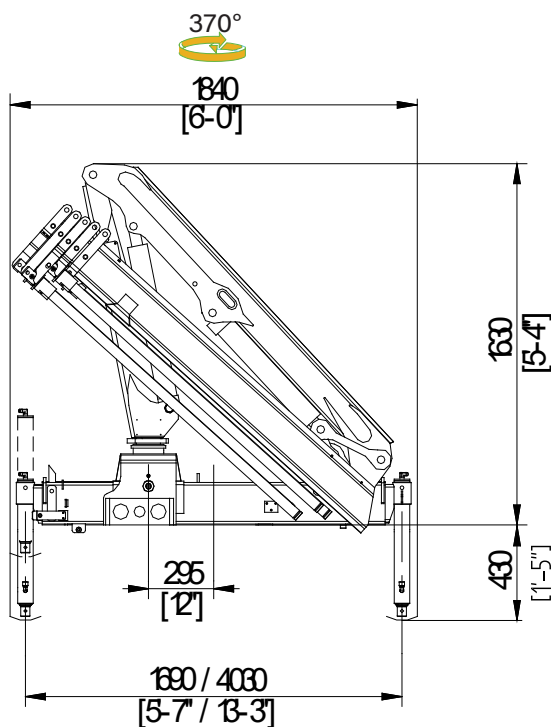





rear truck











42 ESSENTIAL

Technical Data

summarized data

									
	kN.m	bar	l/min	kg	°	mm	mm	mm	mm
42.1	37,6	295	10	520	400°	1840	520	1630	4030
42.2	36,6	295	10	550	400°	1840	520	1630	4030
42.3	34,2	290	10	585	400°	1840	520	1630	4030
42.4	33,2	290	10	610	400°	1840	520	1630	4030

									
	lbs.ft	psi	gal/min	lbs	°	ft/inc	ft/inc	ft/inc	ft/inc
42.1	27196	4278	2,6	1150	400°	6'0"	1'8"	5'4"	13'3"
42.2	26473	4278	2,6	1210	400°	6'0"	1'8"	5'4"	13'3"
42.3	24708	4205	2,6	1290	400°	6'0"	1'8"	5'4"	13'3"
42.4	23999	4205	2,6	1370	400°	6'0"	1'8"	5'4"	13'3"

technical data

Max. lifting moment	37.6 kNm	27196 ft.lbs
Max. hydraulic outreach	9.19 m	30'2"
Slewing angle	400°	400
Slewing torque	455 daNm	3291 ft.lbs
Stabilizer spread	4.03 mt	13'3"
Fitting space required (min./max)	0.52/0.65 m	1'8"/2'2"
Width folded	1.84 m	6'0"
Max. operating pressure	295 bar	4278 psi
Recommended pump capacity	10 l/min	2.6 US gal./min
Dead weight (vers .1)	520 kg	1150 lbs

* Note:
 Technical features are not binding.
 The company reserves itself the right to any modification without notice





**GET READY TO A
BETTER LIFTING
EXPERIENCE**



COPMA 42



knuckle
boom
cranes



Powerful Synergies



CPS



**CPS
STEEL**

CPS GROUP S.P.A.

281 Via Emilia , Castel Bolognese (RA) , 48018
Italy

T +39 0546 653 711

sales.cpsgroup@cps-group.com

service.cpsgroup@cps-group.com

cps-group.com



COPMA MODEL 42 HIGH POWER 3-2021 all rights reserved CPS GROUP

UNICERT
ISO 9001:2008

