



Powerful Synergies



cps-group.com



# COPMA<sup>®</sup> 820

TOP RANGE  
MODEL



# COPMA 820

Performance & Power

**820 HAS COMPACT DIMENSIONS  
AND OPTIMIZED WEIGHTS WITH A  
CUSTOMIZED DESIGN FOR MORE  
POWER AND RELIABILITY AT  
EVERY OPERATOR NEED.**

- **TOP RANGE - HEAVY RANGE model, over 80 Ton/Mt**
- **High tensile strength steel**
- **Efficient safety system**
- **Reliability, speed and precision**
- **Extra long working life cycle**
- **Easier maintenance operations**





# THE MOST POWERFUL CRANE FOR THE TOUGHEST MARKETS



# COPMA 820

More Safety & Security

**DESIGNED WITH THE HIGHEST  
HYDRAULIC SYSTEMS AND THE  
TOUGHEST STRUCTURAL STEEL  
TO PERFORM THE MAXIMUM  
LIFTING CAPACITY.**

- **Superior Hydraulic Technology**
- **Dynamic Electronic Controls**
- **High Degree of User Friendliness**
- **Efficiency and Reliability thanks to superior structural features**
- **More Efficiency with advanced electronic controls**





---

# DESIGNED FOR FLEXIBLE SERVICES

# COPMA 820

## Technical Features

**CUTTING EDGE FEATURES  
FOR MAXIMUM LIFTING  
POWER, STABILITY AND  
OPERATIONAL SAFETY IN EVERY  
WORKING CONDITION.**

### Standard features

- easy use



- control



- structure



### optional features

- control



\*E.C. market specific equipment





### High Speed Extension

Hydraulic system for reducing load losses and bottlenecks for the correct output sequence of the extensions by increasing the speed of 30%-60% thanks to the regenerative valve. Greater continuous performance thanks to lower fluid temperature.



### High Power Velocity Electronic

A valve electronically manages the flow of oil to the distributor by increasing the load capacity of the crane and intervening on the lifting speed. Allowing the reduction of dynamic effects while optimizing performance.

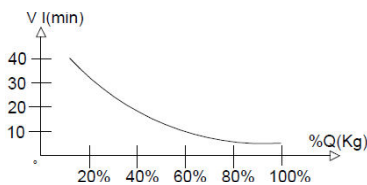

### Transport Alert Device

Sensors on the basement guarantee the correct closing of the beams and a column switch sensor indicates if the crane is in a folded position, no more than 4 Mt in height. The operator is warned with light and sound signals in the truck cabin.



### Crane Monitoring System 2.0

Crane stability control system TES2-TES3 with safety and overload controls and HPVE lifting speed management. Active control on 4-8 working areas according to the model and vehicle stability requirements.



### Negative Boom System

The linkage on the articulation of the secondary boom permits the introduction of loads within restricted spaces. It enables the recovery of the deflection of the extension boom group due to the weight and the load raised on the extensions.

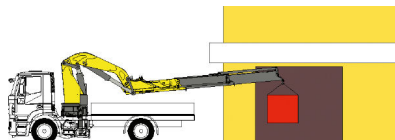

### Electronic Radio Display

A display on the remote control allows the operator to maintain the total control of all the crane functions in real time by managing the work mode, the stability control, and oversee any maintenance and diagnostic messages.

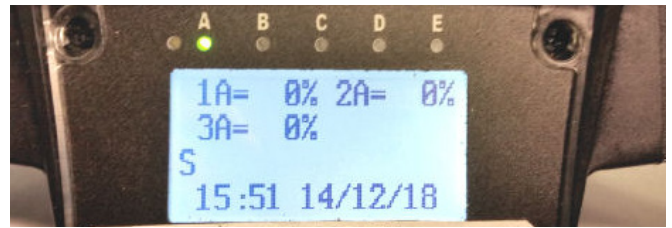

### Hydraulic Lifting Stabilizers 2.0

The stabilizer cylinder is lifted thanks to an auxiliary jack, allowing the vertical movement inside a bush or a rotation around a pin. This easy use system saves time and allows an efficient stabilizer set up.



### Radio Remote Control 3.0

Radio control with directly flanged actuation electronics with proportional distribution. The remote control allows operating the crane while constantly monitoring the areas of operation.



### Truck Electronic Stability 3.0

Active stability control for performance optimization according to the type of stabilization to guarantee maximum safety in all working conditions. Mandatory in the CE market, it helps a better vehicle-crane configuration.

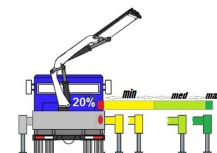

**NCS**  
control  
**Negative Control System**

Slope sensors mounted on the articulated booms of the crane, combined with the electronic control, manage the maximum vertical angle of the arms and the JIB preventing incorrect or dangerous movements by the operator.

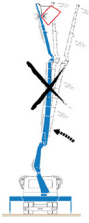

**HTSS**  
structure  
**High Tensile Strength Steel**

The entire high-strength steel structure thanks to an advanced FEM engineering process, develops an extraordinarily light and performing crane structure. In the perfect balance between maximum performance and operational safety.

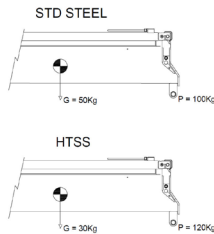

**PJM**  
control  
**Power Jib Monitoring**

The PJM system guarantees to operate with the maximum performance in every working condition thanks to a dynamic variation of the maximum pressure according to the crane arm angles.

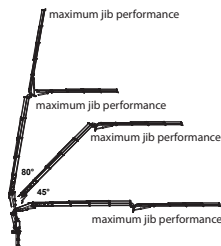

**CRC 4.0**  
control  
**COPMA® Remote Connectivity 4.0**

COPMA® 4.0 remote connectivity to the crane. Bidirectional communication via GPRS for real-time diagnosis and remote setting and / or adjustment of parameters in real time.



**CCLS**  
structure  
**Constant Control Link**

The cranes equipped with connecting rods on the articulations, with a constant lifting moment over the entire working arc, allow to 100% optimize the crane's capacity in positions close to the maximum vertical.

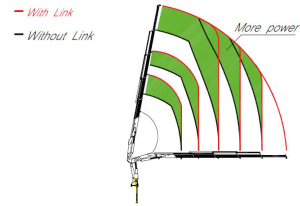

**RES 2.0**  
structure  
**Rotation Endless System 2.0**

Rotating system with bearing and double gearbox, equipped with clearance adjusting system with eccentric shaft. It provides the perfect transmission of the rotation with the bearing.

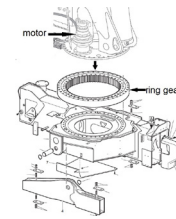

**WLC**  
control  
**Winch Linear Control**

The winch linear electronic control allows pulling the rope according to the working angle of the crane and the JIB. It optimizes the load control and makes every movement easier and safer.

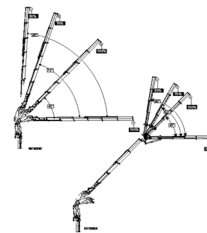

**CMS 3.0**  
control  
**Crane Monitoring System**

Crane stability control system TES2-TES3, with safety and overload controls medium high-range crane and HPVE lifting speed management. Active control on 4-8 working areas according to the model and vehicle stability requirements.

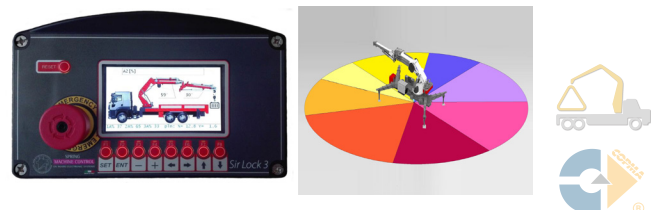



# 820 TOP RANGE

## Load Charts

### 4 extensions

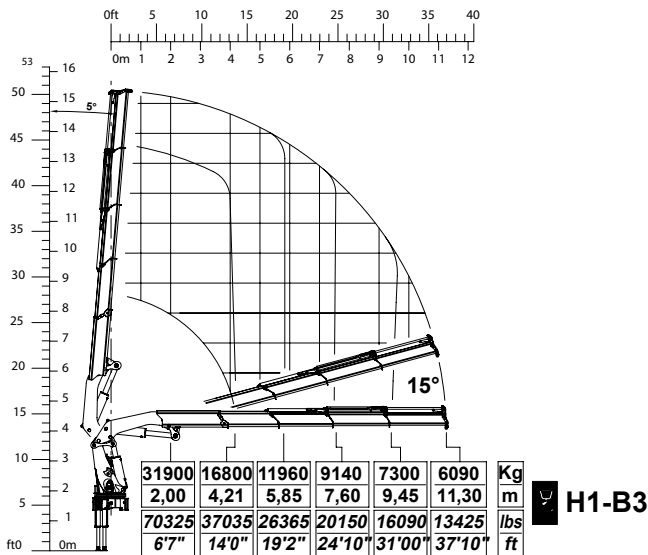

### 6 extensions

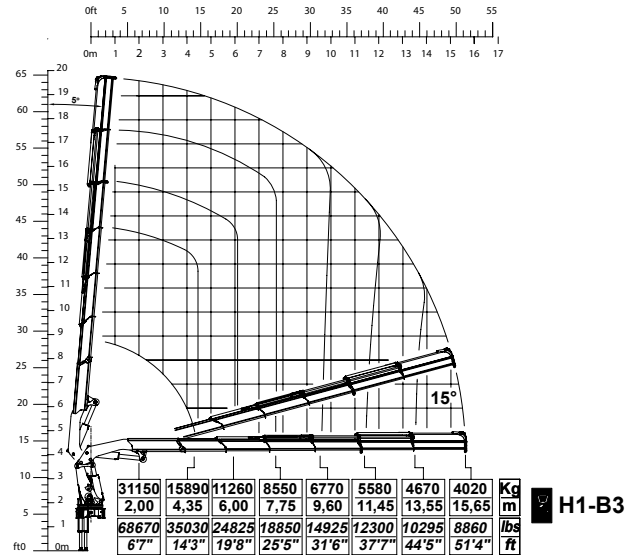

### 8 extensions

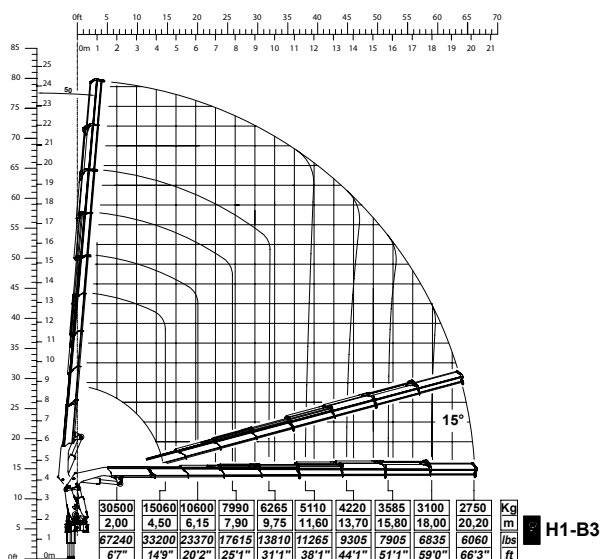

820.6 + J4

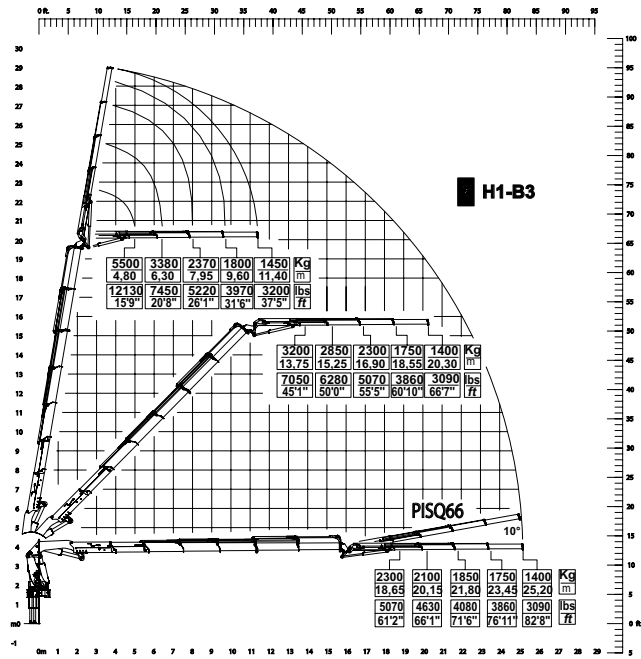

820.6 + J6

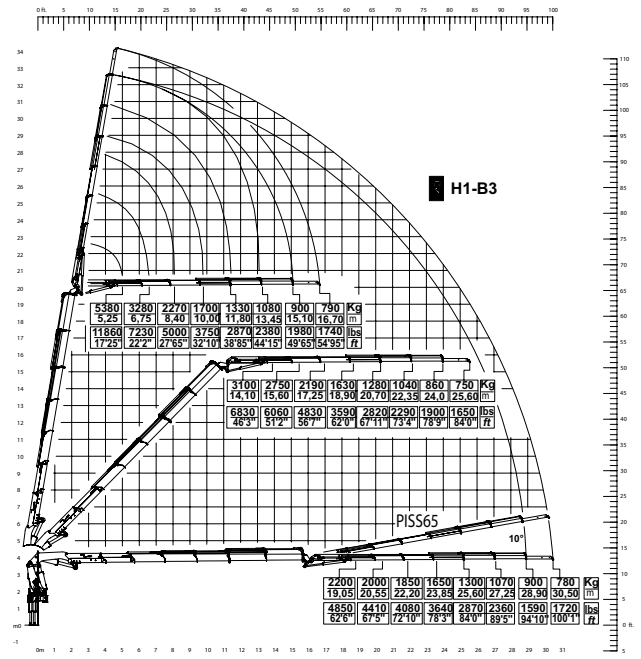

820.8 + J4

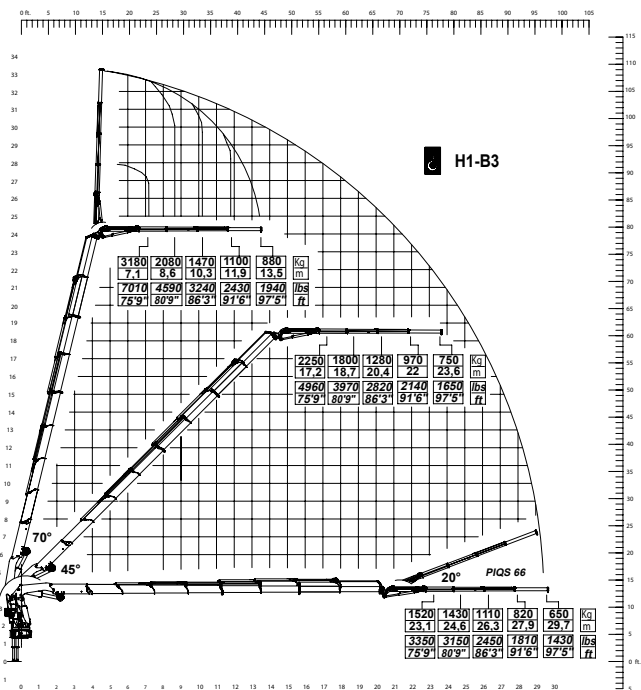

820.8 + J6

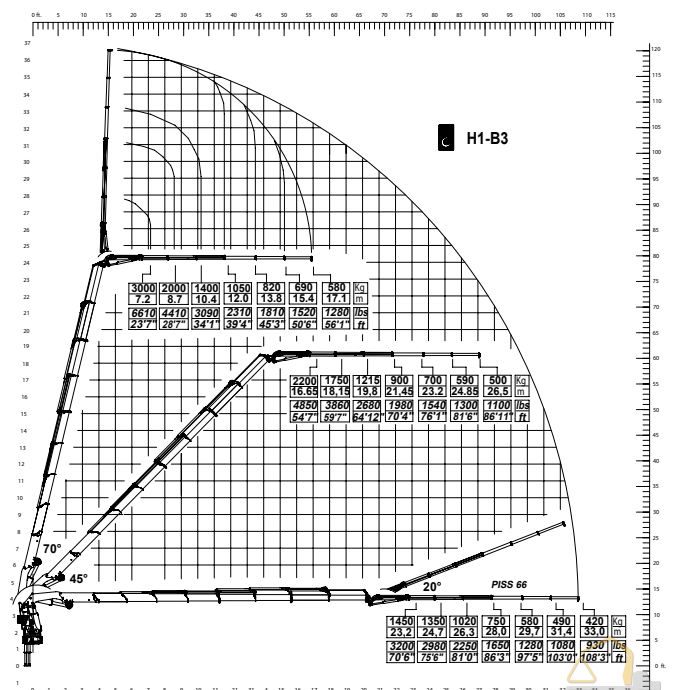

\* Note:

Technical features are not binding. The company reserves itself the right to any modification without notice



# 820 TOP RANGE

## Crane Dimensions

### back cabin left

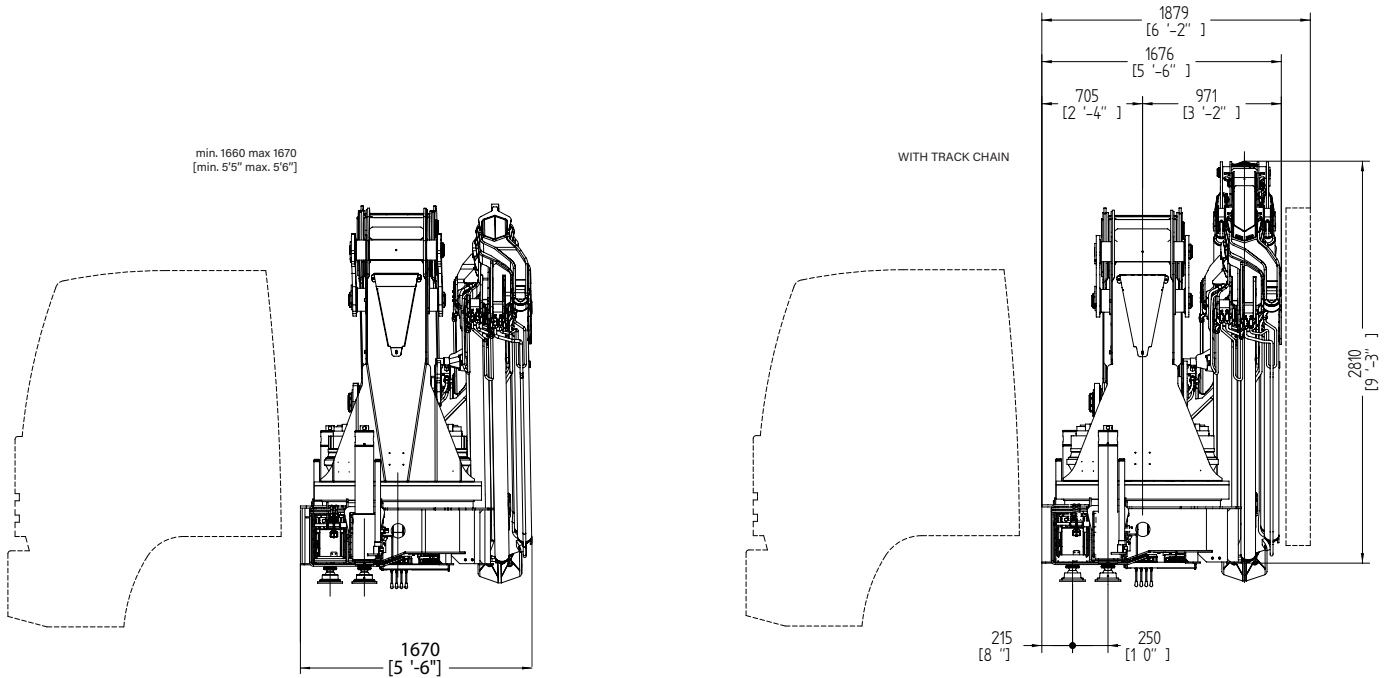

### rear truck

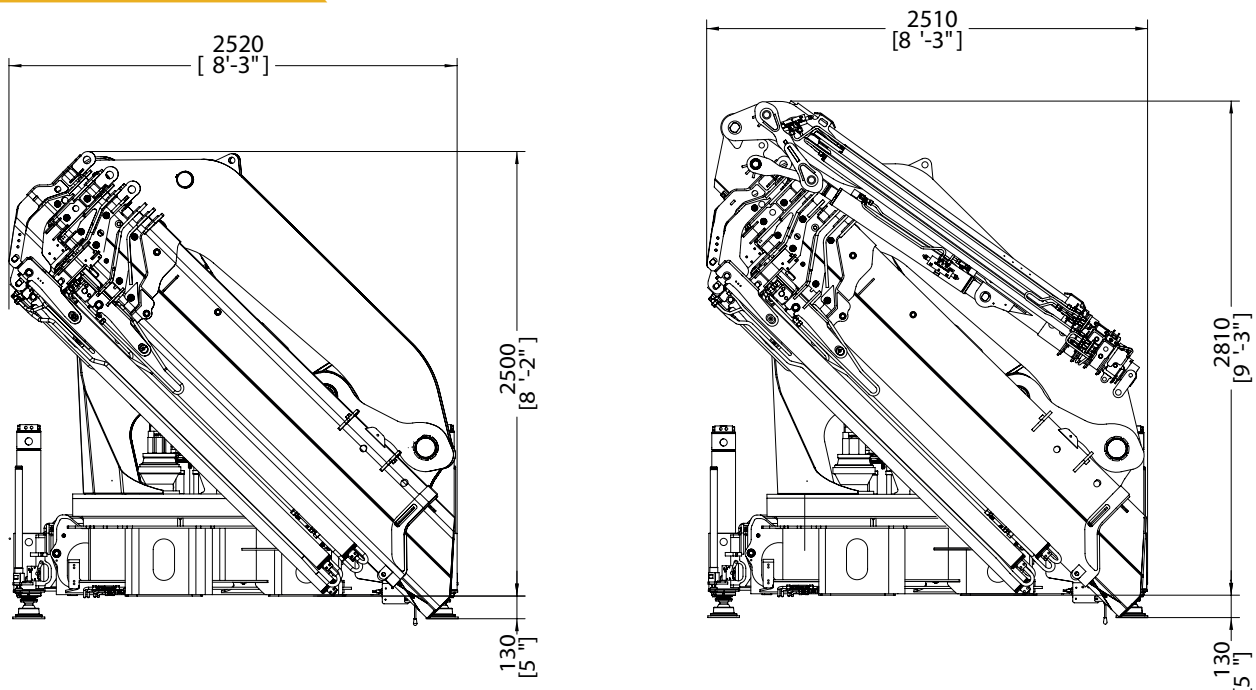

operational

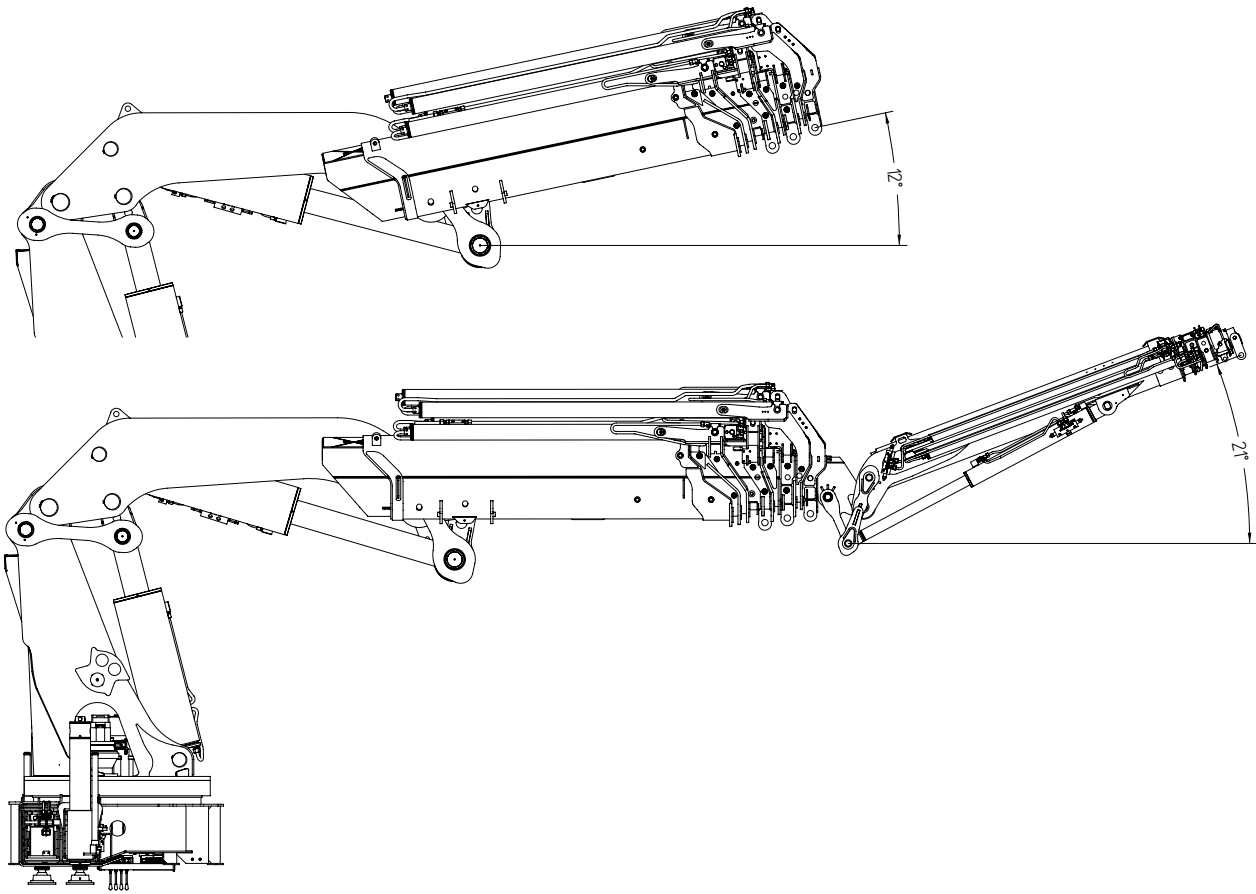

extended outriggers

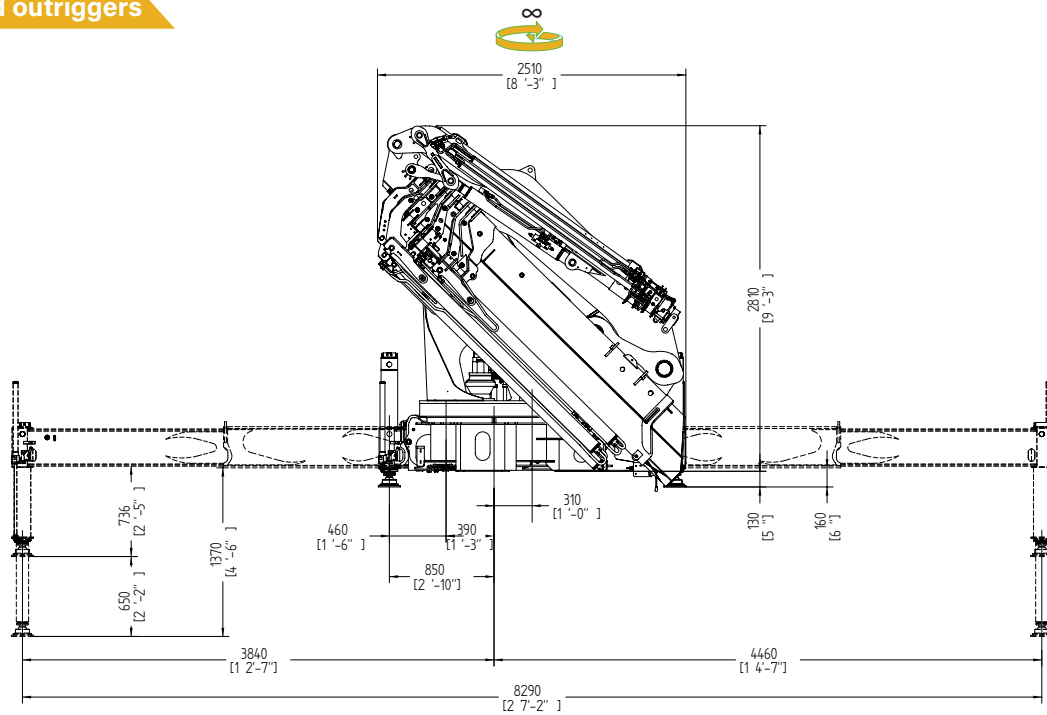









\* Note:  
 Technical features are not binding.  
 The company reserves itself the right to any modification without notice











# 820 TOP RANGE

## Technical Data

### summarized data

									
	kN.m	bar	l/min	kg	°	mm	mm	mm	mm
820.4	694	345	70	7180	∞	2500	1660	2480	8300
820.6	678	345	70	7650	∞	2500	1660	2480	8300
820.6j4	678	345	70	8750	∞	2510	1850	2810	8300
820.6j6	678	345	70	8910	∞	2510	1850	2810	8300
820.8	665	345	70	8100	∞	2520	1670	2500	8300
820.8j4	665	345	70	8870	∞	2510	1850	2810	8300
820.8j6	665	345	70	8960	∞	2510	1850	2810	8300

									
	lbs	psi	gal/min	lbs	°	ft/inc	ft/inc	ft/inc	ft/inc
820.4	511868	5004	18.4	13290	∞	8'2"	5'5'	8'2"	27'3"
820.6	500067	5004	18.4	14330	∞	8'2"	5'5'	8'2"	27'3"
820.6j4	500067	5004	18.4	19290	∞	8'3"	6'1"	9'3"	27'3"
820.6j6	500067	5004	18.4	19640	∞	8'3"	6'1"	9'3"	27'3"
820.8	490479	5004	18.4	17857	∞	8'3"	5'6"	8'2"	27'3"
820.8j4	490479	5004	18.4	19554	∞	8'3"	6'1"	9'3"	27'3"
820.8j6	490479	5004	18.4	19775	∞	8'3"	6'1"	9'3"	27'3"

### technical data

<b>Max. lifting moment</b>	694 kNm	511868 ft.lbs
<b>Max. hydraulic outreach</b>	20.24 m	66'5"
<b>Slewing angle</b>	∞	∞
<b>Slewing torque</b>	82.5 kNm	60849 ft.lbs
<b>Stabilizer spread</b>	8.30 mt	27'3"
<b>Fitting space required (min./max)</b>	1.66 m/1.85 m	5'5"/6'1"
<b>Width folded</b>	2,50 m	8'2"
<b>Max. operating pressure</b>	345 bar	5003 psi
<b>Recommended pump capacity</b>	70 l/min	18.4 US gal./min
<b>Dead weight (vers. 4)</b>	7180 kg	15830 lbs

\* Note:  
 Technical features are not binding.  
 The company reserves itself the right to any modification without notice







**SUPERIOR  
RELIABILITY  
FOR EVERY  
OPERATOR**



# COPMA 820



knuckle  
boom  
cranes



Powerful Synergies



**CPS**



**CPS  
STEEL**

## CPS GROUP S.P.A.

281 Via Emilia , Castel Bolognese (RA) , 48014  
Italy

T +39 0546 653 711

[sales.cpsgroup@cps-group.com](mailto:sales.cpsgroup@cps-group.com)

[service.cpsgroup@cps-group.com](mailto:service.cpsgroup@cps-group.com)

[cps-group.com](http://cps-group.com)

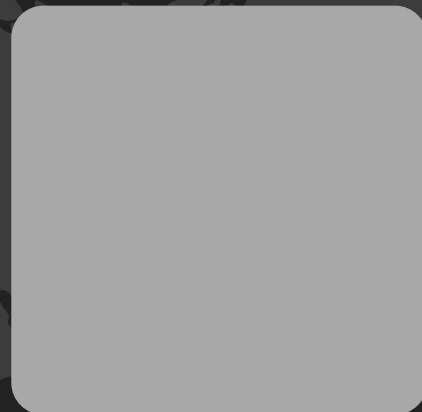

COPMA MODEL 820 TOP RANGE 3-2021 all rights reserved CPS GROUP

UNICERT  
ISO 9001:2008

